

SPECIFICATION FOR APPROVAL

Customer	:	
Customer Part No.	:	
Brightek Part No.	:	V61608G20CFN1
Time	:	2022/01/06

Customer Confirmation	Approval	Checked By	Prepared By
		CB.TAN	GPLIU

V61608G20CFN1

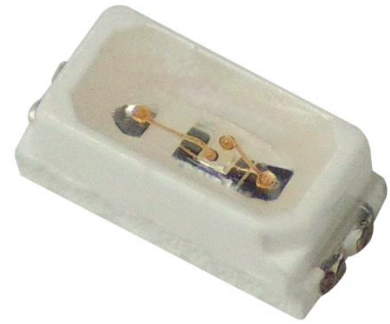

- ◆ **Outline(L*W*H): 1.6*0.8*0.55 mm**
- ◆ **Good thermal dissipation & optical uniformity**

Table of Contents

Product Code Method-----	3
Maximum Rating-----	3
Typical Product Characteristics-----	4
Range of Bins-----	4
Relative Spectral Power Distribution-----	5
Electronic-Optical Characteristics -----	6
Thermal Design for De-rating -----	7
Dimensions -----	8
Reflow Profile-----	9
Test Circuit and Handling Precautions-----	10
Packing-----	11
Packing-----	12
Precautions-----	13

Features

- Forward current: $\leq 30\text{mA}$
- Typical view angle 50% Iv: 120°
- RoHS2.0 and REACH-compliant
- Lens color: water transparent
- Qualified according to JEDEC moisturevity Level 2a
- ESD level 2 kV(HBM)
- Reliability Test: AEC Q-102qualified

Applications

- Indoor lighting applications
- Flat backlight for LCD. Switch and symbol
- Indicator and backlighting for all consumer electronics
- Automotive electronics
- Others applications

■ Product Code Method

V6 - 1608 - G20 - C - F - N1

① ② ③ ④ ⑤ ⑥

①	②	③	④	⑤	⑥
Process Type	Lead Frame Size	Dice wavelength	Cap Color	Spectral Condition Code	Flow Code
V6 : special product	1608: 1.6* 0.8mm	Gxx: green	C: water transparent	F: 20mA	N: no zener 1: no expression above meaning for company

■ Maximum Rating(Ta=25°C)

Characteristics	Symbol	Typical	Unit
DC Forward Current	I _F	30	mA
Pulse Forward Current *3	I _{PF}	100	mA
Reverse Voltage	V _R	5	V
Junction Temperature	T _J	125	°C
Operating Temperature Range	T _{OP}	-40-105	°C
Storage Temperature Range	T _{STG}	-40-105	°C
Soldering Temperature *4	T _{SD}	260	°C
Thermal Resistance Junction/ Solder Point	R _{THJ-S}	130	°C/W
Thermal Resistance Junction/ Ambient Point	R _{THJ-A}	260	°C/W

Notes 1: There is no maximum or typical voltage parameter

2: For other ambient, limited setting of current will be depended on de-rating curves.

3: Duty 1/10, pulse width 0.1ms

4: The maximum of soldering time is 10 seconds in T_{SD}

■ Typical Product Characteristics(Ta=25°C)

Characteristics	Symbol	Min.	Typ.	Max.	Unit	Test Condition
Forward Voltage	V _F	2.8	3.2	3.6	V	I _F =20mA
Luminous Intensity	I _v	630	1000	-	mcd	I _F =20mA
Dominant Wavelength	λ _d	520	-	530	nm	I _F =20mA
Peak Wavelength	λ _p	-	518	-	nm	I _F =20mA
Spectral Width 50%	Δλ	-	31	-	nm	I _F =20mA
Reverse Current	I _R	-	-	10	μA	V _R = 5V
Viewing Angle	2θ _{1/2}	-	120	-	Deg	I _F =20mA

Notes: 1. Measurement Errors:

Forward Voltage: ±0.1V, Luminous Intensity: ±10%I_v, Dominant Wavelength: ±1.0nm, Viewing Angle (2θ_{1/2}): ±5%

2. Electrical-Optical Characteristics (Ta=25°C)

■ Range of Bins
1) Forward Voltage (I_F = 20mA)

Bin Code	Min. V _F (V)	Max. V _F (V)
K	2.8	3.0
L	3.0	3.2
M	3.2	3.4
N	3.4	3.6

2) Luminous Intensity (I_F = 20mA)

Bin Code	Min. I _v (mcd)	Max. I _v (mcd)
20	630	800
21	800	1000
22	1000	1250
23	1250	1600

3) Dominant Wavelength (I_F =20mA)

Bin Code	Min.λ _d (nm)	Max.λ _d (nm)
G5	520	525
G6	525	530

■ **Relative Spectral Power Distribution**

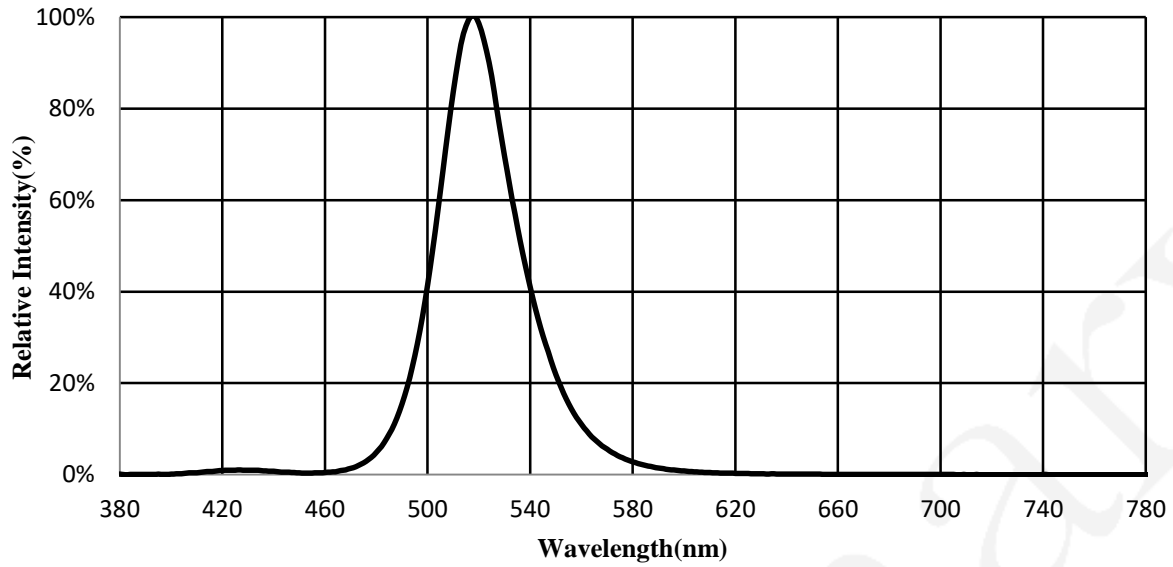

■ **Typical Diagram Characteristics of Radiation**

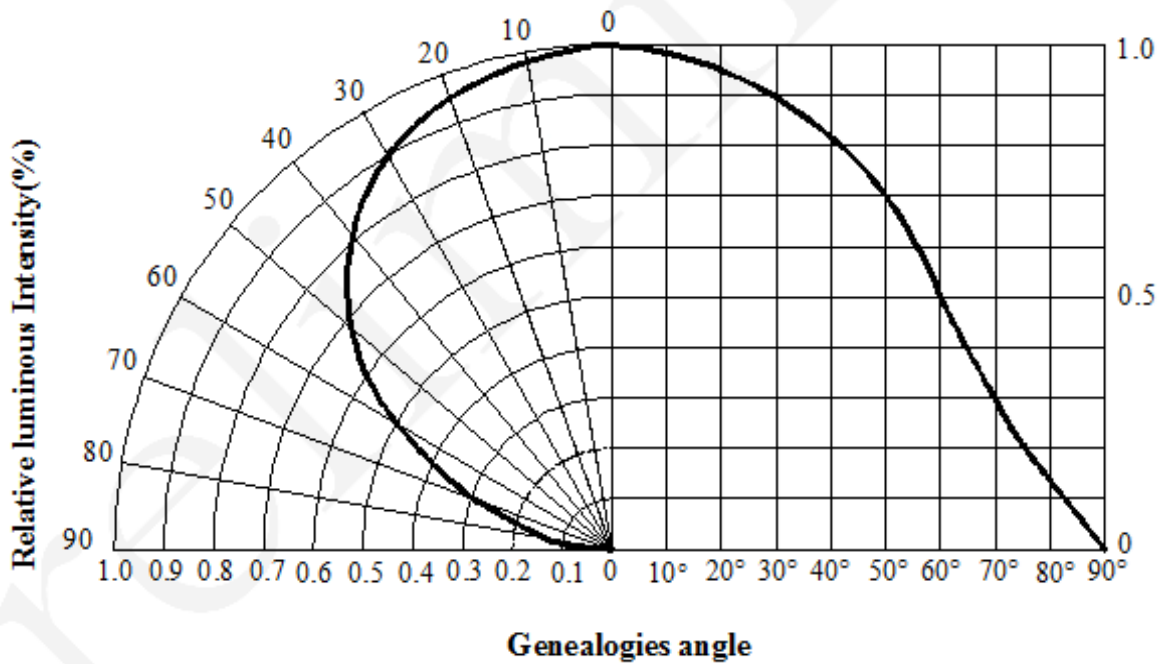

■ Electronic-Optical Characteristics

Relative Forward Current vs. Forward Voltage

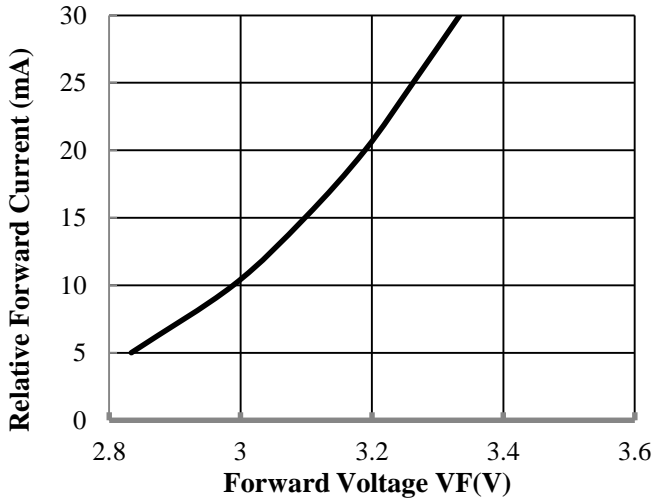

Relative Forward Voltage vs. Solder Temperature

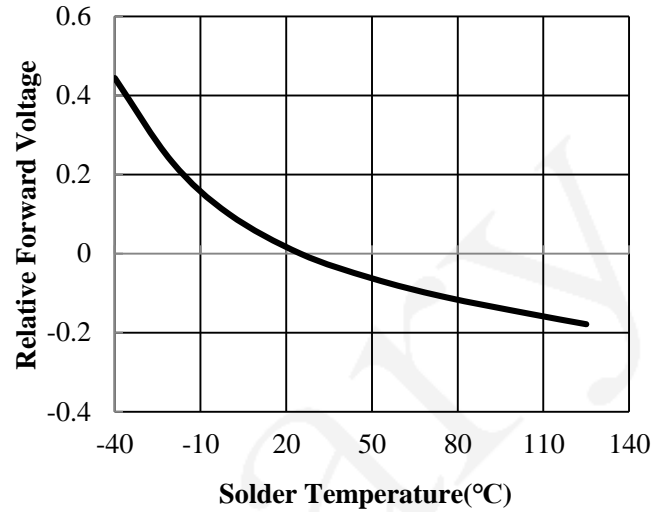

Relative Intensity vs. Forward Current

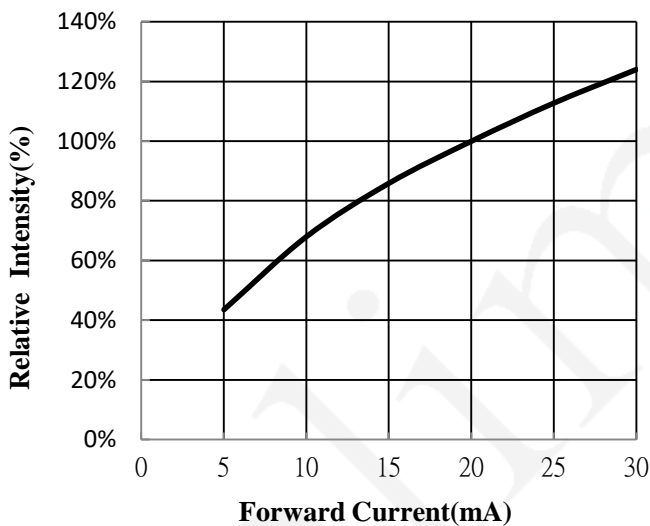

Relative Intensity vs. Solder Temperature

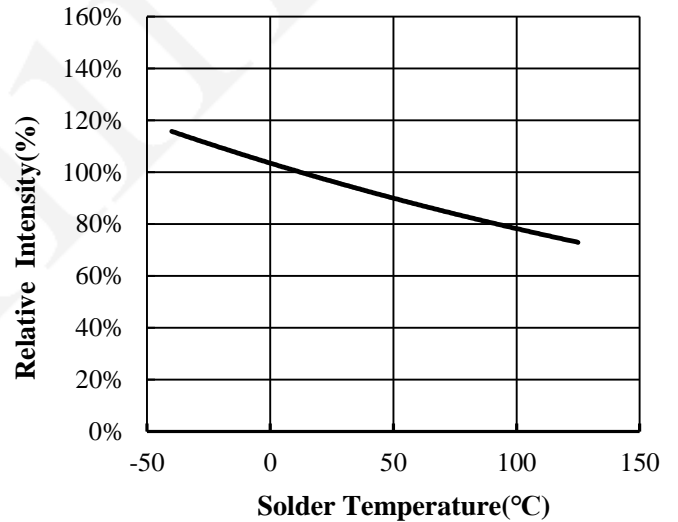

Relative Wavelength shift vs. Forward Current

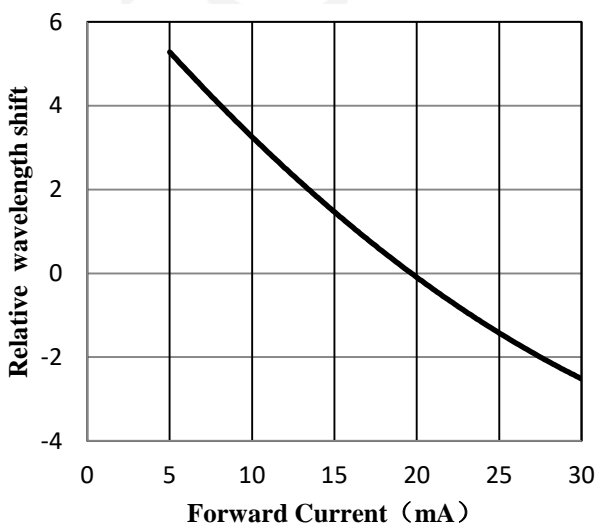

Relative Wavelength shift vs. Solder Temperature

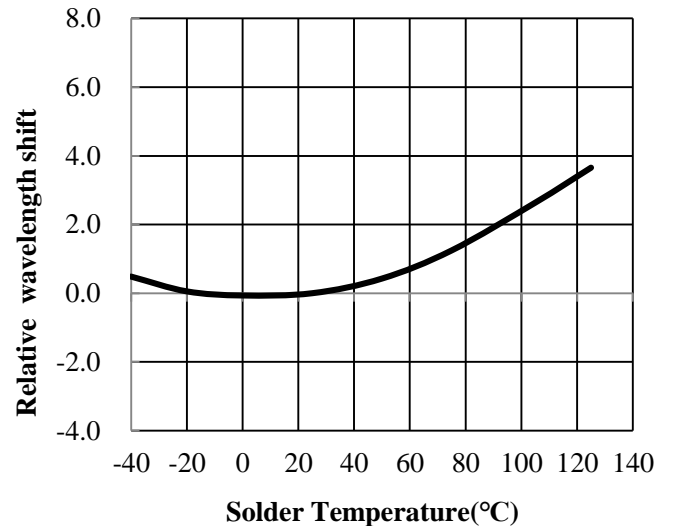

■ Thermal Design for De-rating

The maximum forward current is determined by the thermal resistance between the LED junction and solder point. It is crucial for the end product to be designed in a manner that minimizes the thermal resistance from the solder point to ambient in order to optimize lamp life and optical characteristics.

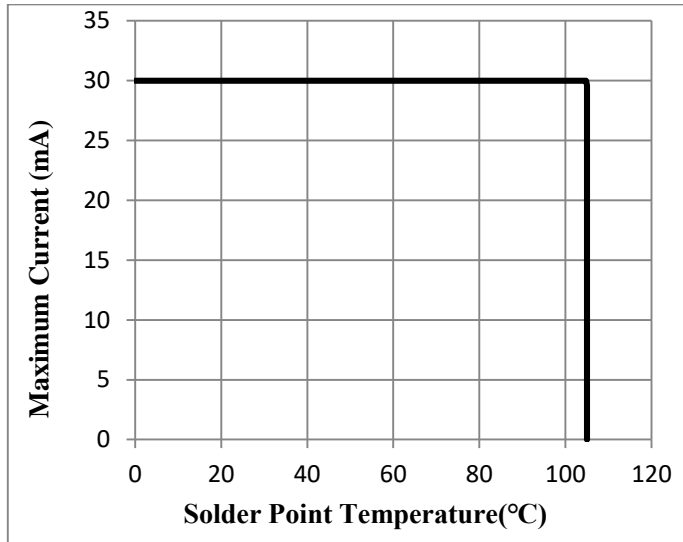

Preliminary

■ Dimensions

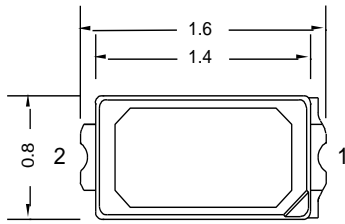

Top View

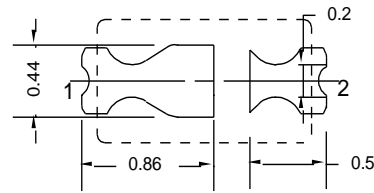

Bottom View

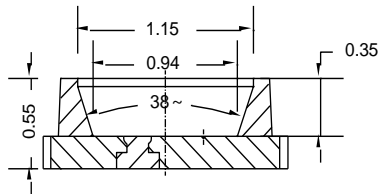

Side View

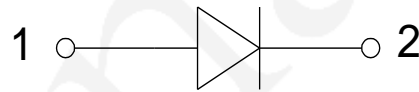

Polarity

Recommend Pad layout

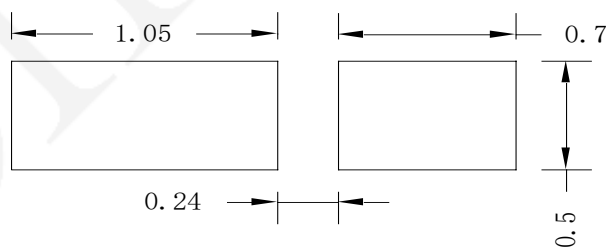

- Notes:
1. All dimensions are in millimeters
 2. Tolerance is ± 0.1 mm unless otherwise noted
 3. Specifications are subject to change without notice.

■ Reflow Profile

SMT Reflow Soldering Profile

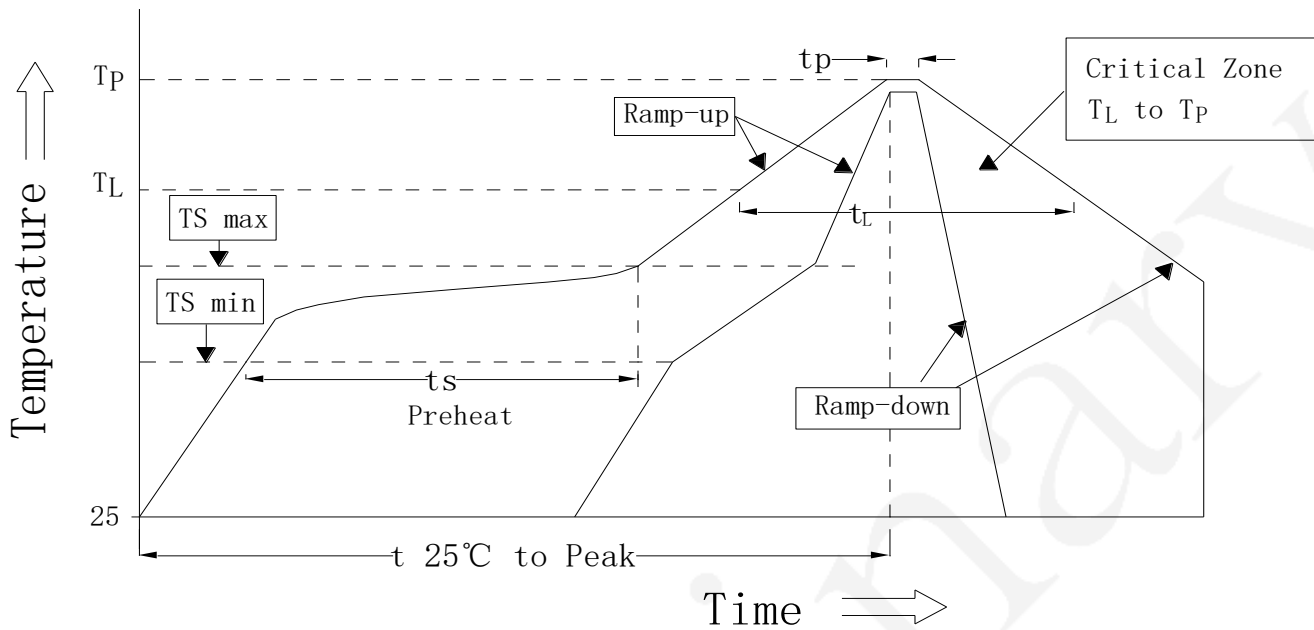

Profile Feature	Symbol	Pb-Free (SnAgCu) Assembly			Unit
		Min.	Recommendation	Max.	
Ramp-up rate to preheat (25°C to 150°C)	-	-	2	3	K/s
Time ts (TS min to TS max)	ts	60	100	120	s
Ramp-up rate to peak (TS max to TP)	-	-	2	3	K/s
Liquidus temperature	TL	-	217	-	°C
Time above liquidus temperature	tL	-	80	100	s
Peak temperature	TP	-	245	260	°C
Time within 5 °C of the specified peak temperature TP - 5 K	tp	-	-	10	s
Ramp-down Rate (TP to 100 °C)	-	-	3	4	K/s
Time 25 °C to TP	-	-	-	480	s

Notes:

1. Do not stress the silicone resin while it is exposed to high temperature.
2. The reflow process should not exceed 3 times.

■ **Test Circuit and Handling Precautions**

1. Test Circuit

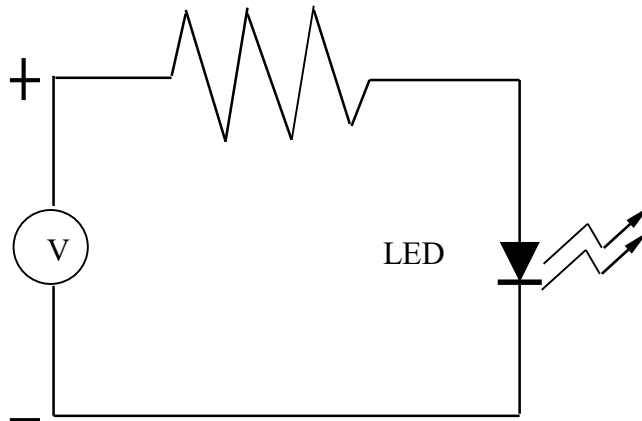

2. Handling Precautions

2.1. Over-current-proof

Customer must apply resistors for protection; otherwise slight voltage shift will cause big current change (Burn out will happen).

2.2. Storage

1). It is recommended to store the products in the following conditions:

Humidity: 60% R.H. Max.

Temperature: 5°C~30°C (41°F~86°F)

2). Shelf life in sealed bag: 12 month at < 5°C~30°C and < 60% R.H. after the package is Opened, the products should be used within four weeks or they should be keeping to stored at ≤20%R.H. with zip-lock sealed.

2.3. Baking

If the package has been opened for more than 4 weeks or over than 12 months in sealed bag, it is recommended to bake the products with the following instruction:

1). 60±3°C X 6hrs and < 5%RH, for reel

2). 125±3°C X 2hrs, for single LED

It shall be normal to see slight color fading of carrier (light yellow) after baking in process

■ Packing

- Feeding Direction (Unit: mm)

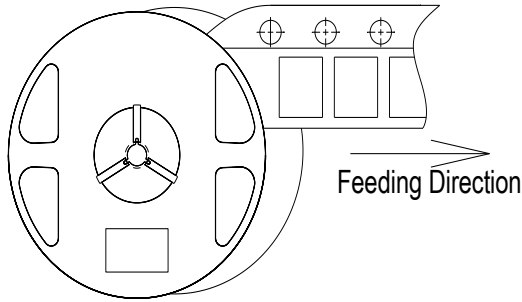

- Dimensions of Reel (Unit: mm)

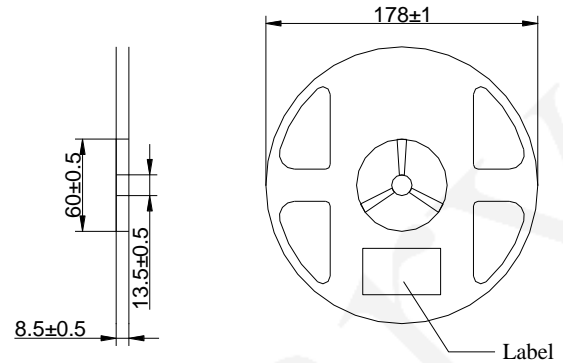

- Dimensions of Tape (Unit: mm)

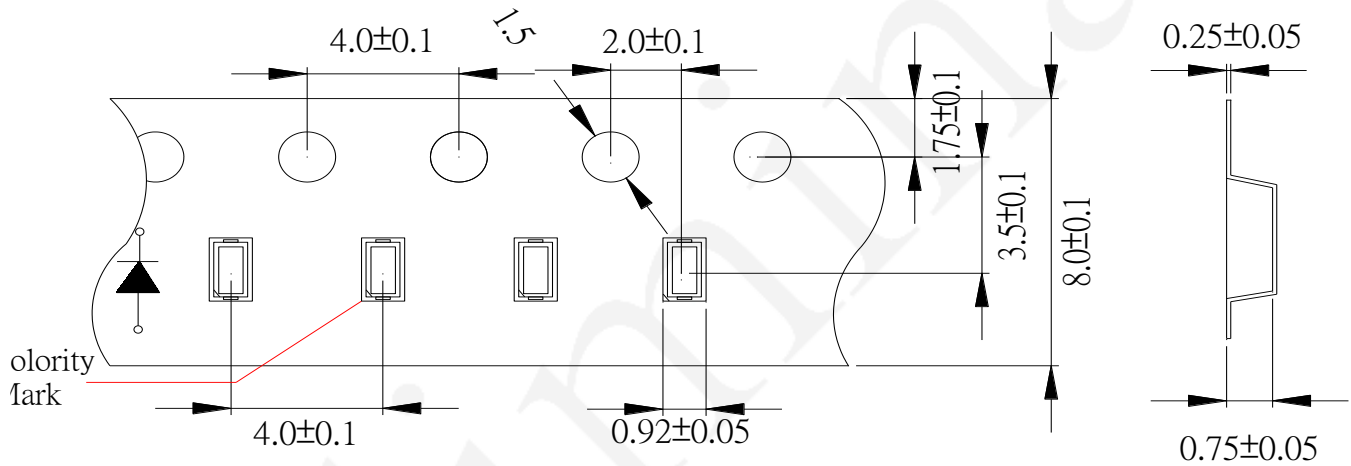

- Arrangement of Tape

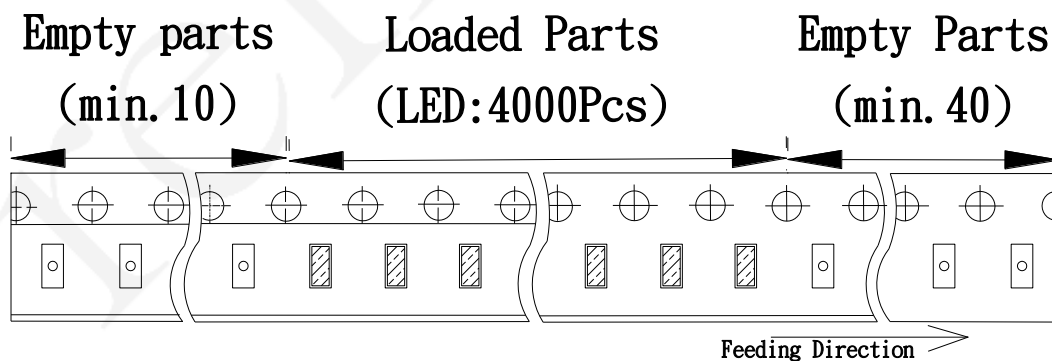

Notes:

1. Empty component pockets are sealed with top cover tape
2. The max loss number of SMD is 2pcs;
3. The cathode is oriented towards the tape sprocket hole in accordance with ANSI/EIA RS-481 specifications;
4. 4,000pcs per reel;
5. The remainder packing in multiples of 500pcs.

■ Packing

● Packaging Specifications

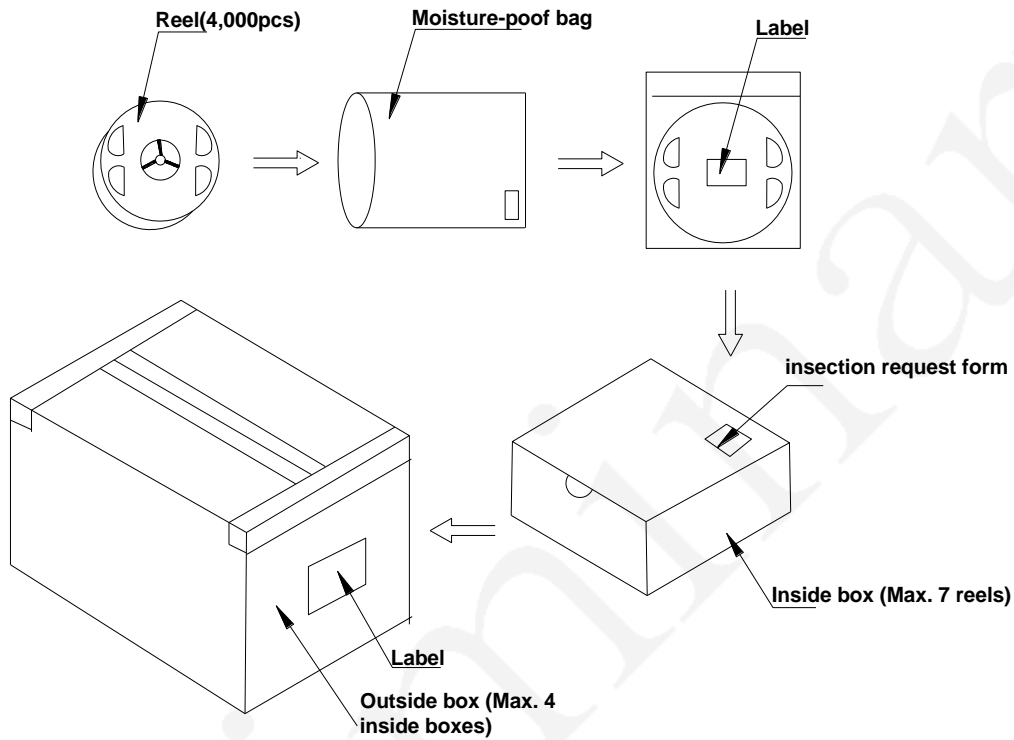

Notes:

Reeled product (max.4,000) is packed in a sealed moisture-proof bag. Seven bags are packed in an inner box (size: about 260 X 230 X 100 mm) and four inner boxes are in an outer box (size: about 480 X 275 X 215 mm). On the label of moisture-proof bag, there should be the information of Part No., Lot No. and quantity number; also the total quantity number should be on inspection request form on outer box.

■ **Precautions**

1. Abnormal situation caused by improper setting of collet

To choose the right collet is the key issue in improving the product's quality. LED is different from other electronic components, which is not only about electrical output but also for optical output. This characteristic made LED more fragile in the process of SMT. If the collet's lowering down height is not well set, it will bring damage to the gold wire at the time of collet's picking up and loading which will cause the LED fail to light up, light up now and then or other quality problems

2. How to choose the collet

During SMT, please choose the collet that has larger outer diameter than the lighting area of lens, in case that improper position of collet will damage the gold wire inside the LED. Different collets fit for different products, please refer to the following pictures cross out

Outer diameter of collet should be larger than the lighting area

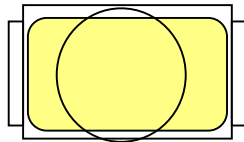

Picture 1(√)

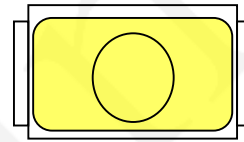

Picture 2(X)

3. Other points for attention

- A. No pressure should be exerted to the epoxy shell of the SMD under high temperature.
- B. Do not scratch or wipe the lens since the lens and gold wire inside are rather fragile and cross out easy to break.
- C. LED should be used as soon as possible when being taken out of the original package, and should be stored in anti-moisture and anti-ESD package.

4. This usage and handling instruction is only for your reference.

Note: Version updates will not be announced and Brightek will have the final interpretation rights